



# Installation Instructions

## Non-Combustible Mantel Shelf

---

AC02780, AC02781, AC02782, AC02783

---





## 1. Kit Contents

- Mantel **(1x)**
- Mounting Bracket 3"x 2" **(1x)**
- Self-drilling screws for Mantel 2 ¼" **(3x)**
- Sharp point screws for mounting bracket 2 ½" **(8x)**

## 2. What You Will Need (not included)

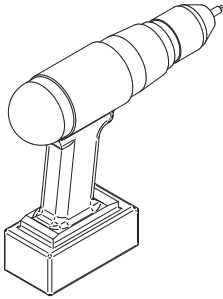

Powered Driver

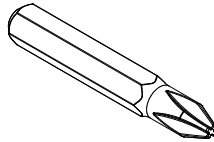

Phillips head drive

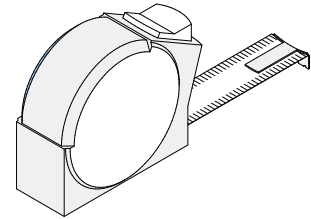

Tape Measure

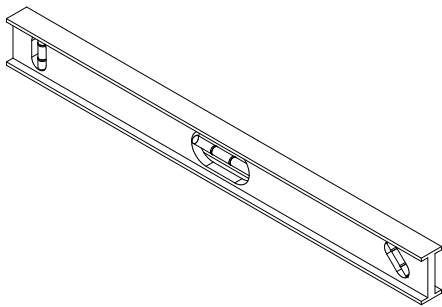

Level

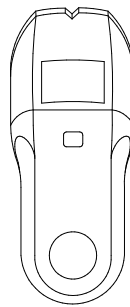

Stud Locator

## 3. Installation Safety Warnings

- Read all instructions before mounting or using the mantel.
- Use the mantel only for its intended use as described in these instructions.
- **DO NOT OVERLOAD MANTEL:** The maximum load for all 60 inch mantels is 150lbs. The maximum load for all 72 inch mantels is 180lbs.
- Mantel “supercast” material meets non combustibility standards in accordance with ASTM E136.
- **WARNING:** Combustible objects placed on or around the mantel must meet your fireplace manufacturer’s requirements for clearances to combustibles.
- **IMPORTANT:** The fasteners supplied with this furnishing are intended for use in standard wood stud walls or 16 gauge metal stud walls only. Minimum wall stud size required is 2”x 4”, with drywall or finished wall surface ranging from ½” to ¾” thick. For all other mounting surfaces, use appropriate fasteners as specified by local building codes or other jurisdiction. For mounting to other wall types; if you are at all unsure of the correct fastening method,

contact your local building official. Improper mounting may lead to property damage, injury, or death.

- Be sure to follow your fireplace manufacturer's clearances to non-combustibles or local code if applicable when determining a location for your mantel. Combustibles set on a non-combustible mantle must meet clearance requirements for combustibles.
- **IMPORTANT:** If you are at all unsure of the correct fastening method, contact your local building official. Improper mounting may lead to property damage, injury, or death.

#### 4. Installation Notes

- Recommended two people to lift and install mantel.
- If you are unable to find studs, you need to open the wall and add wood studs or 16 gauge metal studs if in the non-combustible zone.
- A minimum of 3 studs are required to safely install a 5 ft. mantel. Minimum of 4 studs for 6 ft. mantels. Using 2 1/2" sharp point screws, attach mounting bracket to studs with two screws per stud. See **Figure 1** on page 5 for details.
- If attaching mounting bracket over a masonry surface use proper masonry anchor for the type of surface – consult your fastener supplier. The anchor should be able to support 4 times the load.

## 5. Installation Instructions

*Step 1.* Unpack mantel from box. Remove protective foam. Note: the top flange of mantel has pre-drilled mounting holes.

*Step 2.* Locate mounting bracket and hardware inside of box.

*Step 3.* Determine the vertical and horizontal center for top of mantel on the wall. Mark this location.

*Step 4.* After identifying the correct height for attaching the mantel, draw a horizontal line. Install centered mounting bracket (with the 2" side on the wall) with 2 sharp point screws per stud. Use 1/8" drill bit to drill holes in the mounting bracket. You will need two people to place the mantel on the bracket and check for level, take the mantel off and stabilize the mounting bracket with remaining screws. **See Figure 2.**

*Step 5.* With two people, lift mantel and place over mounting bracket. When centered and flush against the wall, place one 2 1/4" self-drilling screw in the center pre-drilled hole on top of mantel. Screw through mounting angle until fastener head is flush with countersunk hole. **See Figure 3**

**DO NOT OVER-TIGHTEN.**

*Fasten screws through the provided holes on top of mantel.*

**DO NOT SCREW THROUGH THE BOTTOM OF THE MANTEL**

*Step 6.* Shims may be required to level mantel. Install non-combustible shims over the studs. If required, fill screw holes on top surface of mantel with the provided filler.

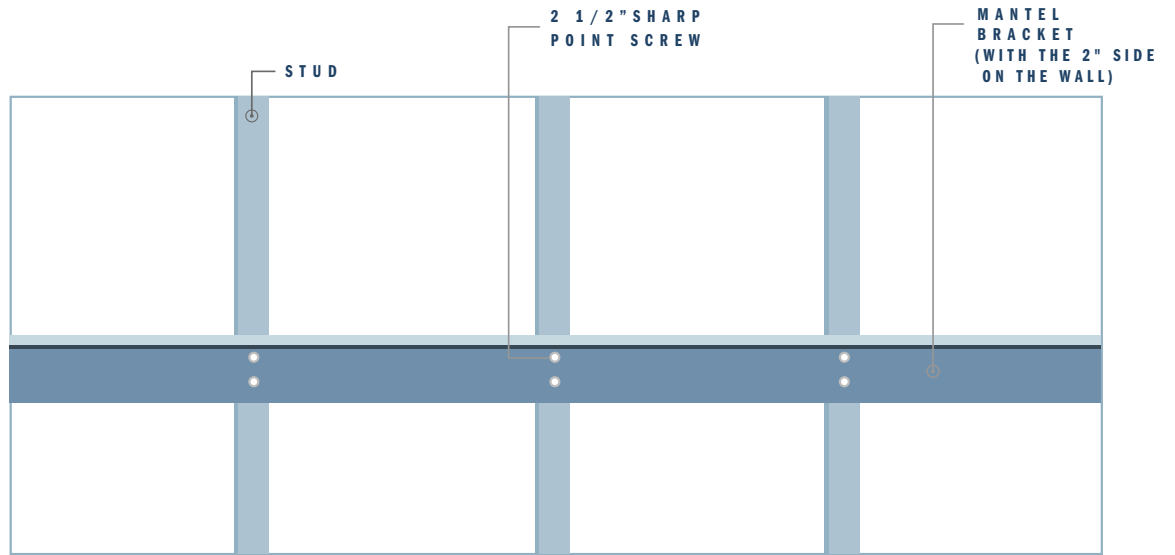

Figure 1: Front Mount

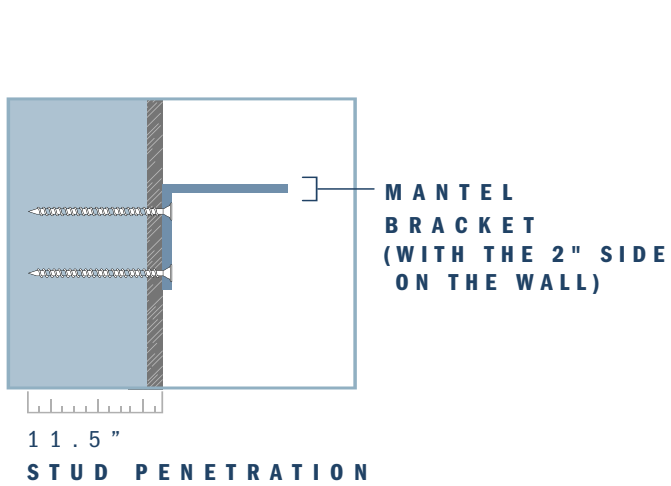

Figure 2: Side Mount

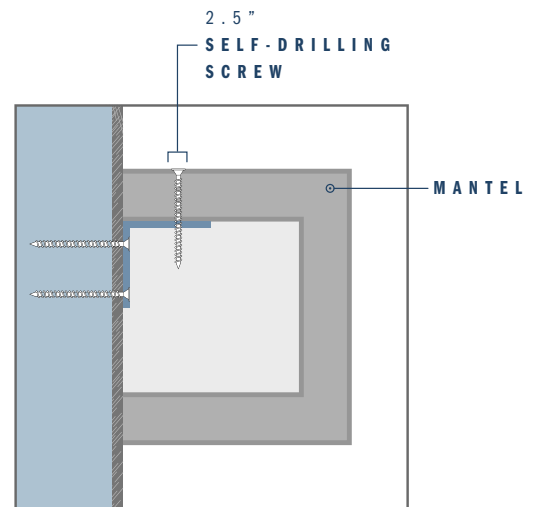

Figure 3: Side Mount with Mantel

## **ONE YEAR WARRANTY**

SBI Heating accessories warrants for the purchaser's first year of ownership that our non combustibile mantle, when reasonably maintained and used, shall be free from any defects in material; or manufacturer's workmanship. Proof of purchase will be required, so keep your receipt. A Return Authorization Number is needed to return goods prepaid to our facility, at 250 rue de Copenhague Saint-Augustin-de-Desmaures, Québec, Canada, G3A 2H3. SBIHA shall not be liable for any consequential or identical damages resulting in loss from the use of this product. In no case will SBIHA's liability exceed the customer's purchase cost.

*Thank you for purchasing an SBI  
Heating accessory!*



SBI HEATING ACCESSORIES  
25 De Copenhagen Street  
Saint-Augustin-de-Desmaures  
Québec, Canada  
G3A 2H3  
1-877-356-6663